	<b>ITTC – Recommended Procedures</b>		<b>7.5 - 02 03-01.3</b> Page 1 of 11	
	<b>Propulsion, Performance Podded Propulsor Tests and Extrapolation</b>		Effective Date 2002	Revision 00

## Contents

- 1 PURPOSE OF PROCEDURE**
- 2 DESCRIPTION OF PODDED PROPULSOR PROCEDURES**
  - 2.1 Propeller Open Water Test (propeller only – without dummy pod)**
  - 2.2 Open Water Propulsion Unit Test**
  - 2.3 Self Propulsion Test**
  - 2.4 Extrapolation Procedure**  
Checklist
- 3 PARAMETERS**
  - 3.1 Parameters to be Taken into Account**
  - 3.2 Recommendations of ITTC for Parameters**
- 4 VALIDATION**
  - 4.1 Benchmark Tests**
- 5 References**

Interim Procedure!

Updated	Approved
Propulsion Committee of 23rd ITTC	23rd ITTC 2002
Date	Date 2002

	<b>ITTC – Recommended Procedures</b>	<b>7.5 - 02 03-01.3</b> Page 2 of 11	
	<b>Propulsion, Performance Podded Propulsor Tests and Extrapolation</b>	Effective Date 2002	Revision 00

## Podded Propulsor Tests and Extrapolation

### 1 PURPOSE OF PROCEDURE

To describe procedures relating to podded propulsors for undertaking propeller open water tests, propulsion unit tests, propulsion tests and for extrapolation of model test results to full scale. All three tests are described here, although these tests may be viewed as options: not all of them may be required in a particular study of a podded propeller system or to carry out a full scale power extrapolation.

It should be emphasized that as a rule the design of podded propulsor propellers should be performed for a prescribed  $K_Q$ - $J$  mode, so special attention should be paid to the accuracy of the instrumentation with regard to torque.

### 2 DESCRIPTION OF PODDED PROPULSOR PROCEDURES

#### 2.1 Propeller Open Water Test (propeller only – without dummy pod)

The procedure for open water tests of the propellers for a ship with podded propulsors as the main thrusters is the same as those of procedure 7.5-02-03-02.1 “Propeller Open Water Tests”. The present section emphasizes the special characteristics of propeller open water tests for propellers of podded propulsor systems. This section is concerned with the tests of a propeller mounted on a drive shaft of an open water test dynamometer without any dummy simulated thruster pod and/or strut configuration.

Open water tests have three goals:

- determination of the open water characteristics of the propeller to be used in propulsion tests and for further propulsion predictions;
- determination of data for propeller design; for example,  $1-w_T$  or  $1-w_Q$
- estimation of characteristics of the final design of the propellers.

Accordingly, open water tests should be carried out at least two rotational speeds (rpm):

- An rpm equal or close to the rpm at which propulsion unit tests will be carried out.
- An rpm which provides for the absence of the impact of laminar flow regions on thrust and torque levels. This may be obtained by tests at a number of rpm values and may be specified as the lowest value of rpm that does not result in a change in  $K_T$  and  $K_Q$  when rpm is increased.

The latter is especially important for pulling thruster units (tractor type) because the absence of the hull, or pod and strut, in front of the propeller eliminates additional turbulence in the propeller inflow and thus increases the danger of scale effect in the results of propulsion tests.

Both for pulling and pushing podded propulsion units the model hub should correspond to the realistic propeller hub configuration. For a pushing thruster, a streamlined hub cap of sufficient length to ensure that the inflow over the propeller hub is parallel to the shaft should be mounted upstream of the propeller model.

	<b>ITTC – Recommended Procedures</b>	<b>7.5 - 02 03-01.3</b> Page 3 of 11	
	<b>Propulsion, Performance Podded Propulsor Tests and Extrapolation</b>	Effective Date 2002	Revision 00

This is similar to the set up for testing of a conventional propeller described in the procedure 7.5-02-03-02.1 “Propeller Open Water Tests”.

For a pulling thruster, the forward hub cap should correspond exactly to the configuration of the actual hub cap intended for the thruster unit. The connection between the cap and the hub should be smooth and without a gap. The size and shape of the hub cap, hub and aft fairing should be recorded. An example is shown in Figure 2.1.1.

The aft fairing for both pushing and pulling propellers, which should rotate, should be made with a slope of no more than 10 degrees between its conical surface and the shaft line. For pulling propellers with a high hub cone angle, it is acceptable to make a cylindrical intermediate portion of the aft fairing between the hub and the conical portion of the aft fairing in order to prevent a big knuckle angle between the hub and aft fairing surface. Also, a faired transition at the forward end of the adaptor could be implemented as shown in Fig 2.1.1.

If the aft fairing piece is fixed from rotation, with a gap between the aft fairing and the propeller hub, then the static pressure induced by the propeller will augment the measured thrust. The degree of this is dependent on the propeller characteristics and cone angle of the propeller hub.

Pre-test: Apart from the calibrations of the measuring devices, runs are to be made to measure the influence of the set of conical hub, forward hub cap and aft fairing. These measurements are to be made in conjunction with a propeller hub without blades and having the same shape as the real propeller hub. The range

of measurements should cover those for the open water tests in terms of rotational speed and speed of advance. The results of these pre-tests are to be recorded and subtracted from the thrust and torque values from the open water tests.

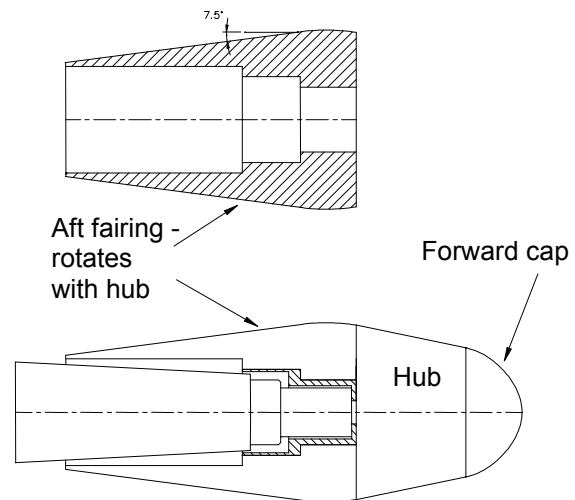

Figure 2.1.1. Example of hub geometry for an open water test with a tractor type propeller.

## 2.2 Open Water Propulsion Unit Test

Open water propulsion unit tests are done to:

- determine the open water characteristics of the whole propulsion unit to be used in the propulsion tests and for propulsion prediction;
- determine data for propulsion prediction, for example the wake fraction;
- optimise the pod units;
- assess the effect of Reynolds numbers on performance;
- compare open water test results of unit and propeller, to gain information on the impact of pod and strut on propeller characteristics.

The open water propulsion unit test is an open water test for the complete pod unit consisting of propeller and pod housing. A special device is required for carrying out this test.

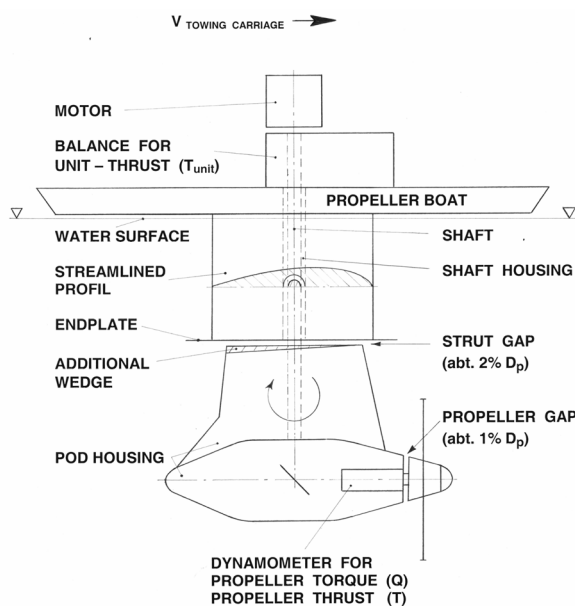

Fig. 2.2.1 Pod-drive in the propulsion unit test.

The recommended configuration is shown in Fig 2.2.1. A special aspect of this configuration is the insensitivity of the unit thrust measurement to the propeller gap pressure.

The propeller is driven by a motor at the top via a belt or gear drive in the same manner as in the propulsion test. In order to avoid the influence of the water surface, the propeller shaft must be submerged at least  $1.5 \times D_p$ , or preferably  $2 \times D_p$ . The exposed part of the shaft between the upper end of the pod and the bottom of the propeller boat must be protected by a streamlined profile in order to avoid drag on the shaft itself. This profile is fixed to the bot-

tom of the propeller boat. The bottom of the profile is fitted with a thin endplate in order to minimise the effects in the strut gap. The endplate is arranged parallel to the water surface.

The bottom of the propeller boat has to be 5 to 10 mm above the water surface in order to avoid waves caused by the strut piercing the surface.

The propeller shaft must be arranged parallel to the water surface. In most cases this arrangement leads to an open wedge at the upper, aft end of the pod strut. This open part should be filled out with an additional wedge in order to make the upper surface of the pod strut parallel to the endplate of the streamlined profile and to ensure an uniform strut gap.

The width of the propeller gap has an unavoidable influence on the measured propeller thrust, as shown in Fig 2.2.2. For that reason it is very important to have fixed rules for the gap width. The recommendation is that the width of the propeller gap is to be about 1% of the propeller diameter. Mewis (1) has shown that the width of the propeller gap has negligible influence on the unit thrust.

The width of the strut gap has a small influence on the measured thrust of the unit, as shown in Fig. 2.2.3. This gap must be parallel to the water surface. The recommended width of the strut gap is about 2% of the propeller diameter.

The thrust and torque of the propeller,  $T$  and  $Q$ , should be measured using a dynamometer on the propeller shaft positioned as close as possible to the propeller in order to avoid effects from mechanical friction. Alternatively the torque can be measured at the top of the

 <b>INTERNATIONAL TOWING TANK CONFERENCE</b>	<b>ITTC – Recommended Procedures</b>	<b>7.5 - 02</b> <b>03-01.3</b> Page 5 of 11	
	<b>Propulsion, Performance</b> <b>Podded Propulsor Tests</b> <b>and Extrapolation</b>	Effective Date 2002	Revision 00

unit, but in this case mechanical losses must be accounted for by the results from tests in which the propeller has been replaced by a dummy hub of the same mass. The thrust of the whole unit,  $T^{unit}$ , is to be measured using a balance at the junction between the strut and the propeller boat. The propeller boat is fixed to the towing carriage. The rotation rate of the propeller,  $n$ , and the velocity of the towing carriage are to be measured in the usual manner.

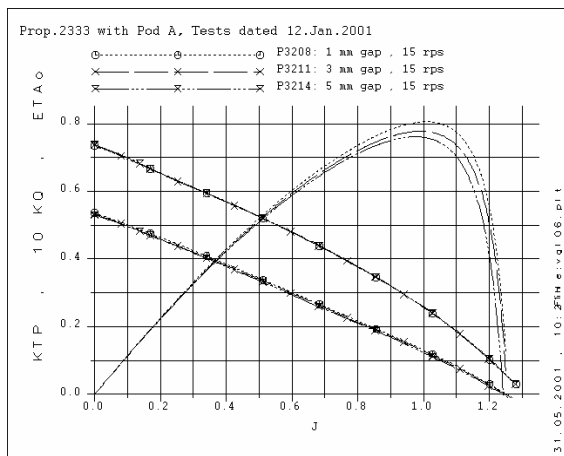



Fig. 2.2.2 Open water characteristics of a pod unit based on measured propeller thrust for different propeller gap widths, Mewis (2001).

An alternative configuration of the pod unit open water test would be to replace the right angle unit drive with a conventional open water drive shaft entering the aft end of the pod. This set-up would be somewhat idealized due to the downstream shaft exiting the pod unit. Pod drag would still be measured with the dynamometry shown in Fig. 2.2.1. The configuration allows the use of conventional dynamometry, but excludes the possibility of testing the unit yawed to the inflow.

In the case of propellers with thick conical hubs, common in pod arrangements and in thrusters, the thrust transferred by the propeller shaft deviates substantially from the thrust of a propeller with a cylindrical hub (especially with tractor units). Apparently, the shape and size of the hub, the housing and the strut downstream of a working propeller cause an internal longitudinal force acting in the gap between the hub and the housing. This internal force is included in the measurements of the thrust in the propeller shaft. Departures between the thrust of a propeller with a cylindrical hub and the that of a propeller with a conical hub have been found to be as high as 8 per cent for the extremely large conical hubs of pulling propellers on pods. The gap pressure effect can be minimised by using a minimum cross sectional area between the rotating propeller hub and the fixed part of the driving equipment. A possible technique for correcting the propeller shaft thrust is to measure the gap pressure, although this adds to the complexity of the dynamometer. This can be done with electronic, strain gage type pressure gages. At least two gages mounted 180 degrees apart are recommended to ensure sufficient accuracy.

The Propulsion Unit Test is to be carried out using the same procedure as the Open Water Test as described in 2.1. The correction to full scale of the  $K_T$  and  $K_Q$  values of the propeller should be done in the same manner as for propellers alone. One approach is to use the method proposed in the ITTC 1978 extrapolation procedure. The drag of the model pod housing should be corrected according to the particular experience of the model basin.

 INTERNATIONAL TOWING TANK CONFERENCE	<b>ITTC – Recommended Procedures</b>	<b>7.5 - 02 03-01.3</b> Page 6 of 11	
	<b>Propulsion, Performance Podded Propulsor Tests and Extrapolation</b>	Effective Date 2002	Revision 00

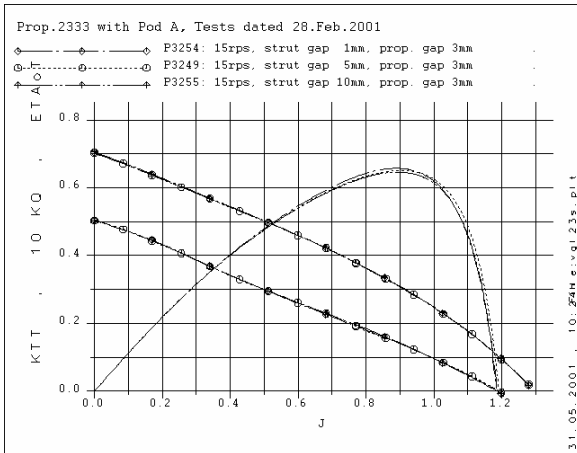

Fig. 2.2.3 Open water characteristics of a pod unit based on measured thrust of the unit for different strut gap widths, Mewis (2001).

### 2.3 Self Propulsion Test

It is recommended that for ships fitted with podded propulsors, propulsion tests be conducted with both the speed and the propulsor load varied independently. This propulsion test is to be carried out on the geometrically similar ship model, pod configuration, and geometrically similar propeller.

The propulsion test is recommended to be carried out in the following manner: the propellers at the pod are preferably to be driven from the hull, either by a timing belt or by a gear wheel transmission. The thrust and torque of the propeller,  $T$  and  $Q$ , are to be measured on the propeller shaft as close as possible to the propeller, preferably inside the hub of the propeller in order to avoid effects from mechanical friction on the thrust and the torque. Also the longitudinal force transferred by the pod strut to the hull,  $T^{unit}$ , is to be measured at the junction between the hull and the shaft housing. Further, the rotation rate of the propeller,  $n$ , the

longitudinal towing force,  $F$ , and the velocity of the ship model,  $V$ , are to be measured in the usual manner.

A point of special concern is the avoidance of air leakage from the hull through the connection with the pod strut to prevent the propeller becoming ventilated. Care is to be taken that the Reynolds number of the flow about the pod is sufficiently high to avoid extensive laminar flow and separation. Turbulence tripping at the pod housing helps to remedy locally delayed flow transition. Transitional flow on the pod housing is more of an issue on pushing units.

The difference between the measured propeller thrust  $T$  and the unit thrust,  $T^{unit}$ , can in the first instance be taken as a measure for the drag of the pod housing. However, refinement is needed here because the pressure in the gap between the rotating hub and the fixed part of the housing leads to an internal force which is included in the propeller thrust. Hence, this internal force may seriously disrupt the accurate determination of the drag of the pod housing as the difference of the two large forces  $T$  and  $T^{unit}$ . Scale effect is present on the drag of the pod housing and corrections according to the particular experience of the towing tank institution should be applied to the drag of the pod housing (e.g. Holtrop 2001).

Alternatively, the pod drag can be obtained through resistance tests with and without the unpropelled pods. This method allows the pod drag to be scaled as an “appendage” with its own characteristic length. The effect of the propeller on pod drag scaling would not be included. Also, when using this method, the thrust deduction,  $1-t$ , would include the augmentation of the pod drag due to propeller induction.

	<b>ITTC – Recommended Procedures</b>		<b>7.5 - 02 03-01.3</b> Page 7 of 11	
	<b>Propulsion, Performance Podded Propulsor Tests and Extrapolation</b>		Effective Date 2002	Revision 00

In model experiments in which the pod arrangement is optimised, the longitudinal and lateral location of the pod under the stern, its zero helm angle and its tilt angle are varied systematically. In such tests care is to be taken that hull-propeller tip clearances are preserved. This applies particularly to tilt angle optimisation tests, in which it is recommended to retain the position of the propeller blade tip in its top position and to rotate the pod unit about this point.

Ideally in self propulsion tests, the unit thrust is measured inside the ship model using a (standard) six-component measuring frame. In one system in use, this frame consists of two parallel plates between which the elements with the actual strain-gauge transducers are fitted. The top table carries the driving motors and gear box when needed. A special device enables easy adjustment of the helm and tilt angles if desired.

The pod configuration can be geometrically modeled around standard model thruster units. Again in one system in use, these standard thruster units enable the propeller thrust and propeller torque to be measured inside the propeller hub, outboard of the bearings and sealing. The model thruster is driven by a vertical shaft in a rigid tube. This shaft tube passes through an opening inside the pod strut and through a corresponding opening in the ship model. This opening is of standard dimensions and cover plates for each of the test configurations are made available in advance, depending on the range of tilt and helm angles to be investigated. A recess in the model hull in combination with an elongated pod strut is used for experimental research of the tilt angle. Thus, the

need to manufacture a range of separate filling pieces is avoided.

The drive shaft and the connections between the pod housing and strut and the plate of the six-component measuring frame do not touch the ship model itself. In order to avoid air leakage to the pod and the pod propeller and to avoid water entering the ship model in the opposite direction, a very thin flexible latex sheet closes the opening between the driving shaft tube and the model hull.

The forces and moments recorded by the transducers in the measuring frame are processed in a standard manner. Cross-talk corrections and the calibrations are linear to a high degree for the measurement set-up employed. The processing of the measurement data implies first the multiplication of the measurement vector by the inverse of the calibration matrix and, secondly, the derivation of the longitudinal force component, which is the unit thrust, by decomposition of the three forces measured in the co-ordinate system of the measuring frame.

Prior to each propulsion test an "in-situ" static-load test is carried out. This is done not only to check the calibration factors for the built-in configuration, it also serves to check if there are unintentional contacts between the pod unit, inclusive of the driving equipment, and the ship model.

## 2.4 Extrapolation Procedure

This section gives an outline of extrapolation methods to be followed with a podded propulsion drive. Emphasis is placed on the

	<b>ITTC – Recommended Procedures</b>		<b>7.5 - 02 03-01.3</b> Page 8 of 11	
	<b>Propulsion, Performance Podded Propulsor Tests and Extrapolation</b>		Effective Date 2002	Revision 00

unusual aspects of the extrapolation in comparison with a conventional system.

For open-shaft propeller arrangements, typical for twin-screw ships, the scale effect on the wake is small and this is also the case for podded propulsor arrangements. Until sufficient experience is built up with podded propulsor tests, some guidance for the wake scale effect can be found from the particular experience of the model basin.

The scale effect on the drag of the housing of the thruster or pod must be considered. This is difficult for the following reasons:

- (a) the drag of the housing is difficult to measure at model scale as it is obtained from the difference between the two large quantities  $T$  and  $T_{unit}$ ;
- (b) its magnitude depends on the scale factor, the shape of the housing, its orientation to the local flow direction, the size of the housing, the propeller-induced flow field and the inflow velocity, including the wake scale effect on the inflow velocity and the potential for flow separation;
- (c) the loading of the propeller causes an induced flow field of which the magnitude is uncertain due to the interaction with the pod or thruster housing.
- (d) a (small but distinct) part of the drag of the pod housing is compensated by the stator action of the pod strut in pulling propeller configurations.

The drag of the housing at model scale is defined experimentally as the difference between the total unit thrust  $T_{unit}$  and the thrust force which is exerted on the hub of the propeller by the blades. The unit thrust  $T_{unit}$  is measured in the experiment at the junction of the

hull and the shaft housing. One method to account for the scale effect on the drag of the housing is discussed by Holtrop (2001). Both frictional and pressure drag components must be accounted for in this process.



### Checklist

(See Figure 2.4.2 for a block diagram.)

1. Carry out load varying test OR carry out a test at the self propulsion loading only.
2. Obtain the thrust deduction fraction directly from the load varying test data or from 7 below. The pod unit thrust,  $T_{unit}^t$ , is used in this step.
3. Calculate the ship self propulsion point.
4. **Optional:** Obtain the form factor.
5. Extrapolate full scale thrust,  $T_{unit}$ , at the ship self propulsion point.
6. **Or:** Obtain the model resistance at the self propulsion point, extrapolate the resistance and obtain the full scale thrust through application of the thrust deduction fraction.
7. **Or:** Obtain the model resistance from a resistance test and extrapolate this resistance in the normal way. Obtain the thrust deduction fraction from comparison of the model thrust at the self propulsion point and the model resistance. The pod unit thrust,  $T_{unit}$ , is used in this step.
8. Estimate the wake scale effect.
9. **Or:** Estimate the wake fraction through a thrust or torque identity using the open water test results on the podded propulsor unit. Estimate any wake scale effect.
10. Correct the thrust ( $T_{unit}$ ) and torque coefficients of the podded propulsor unit in the behind condition i.) for Reynolds number scale effects of the drag over the propeller blades and ii.) for the resistance of the pod-

	<b>ITTC – Recommended Procedures</b>	<b>7.5 - 02 03-01.3</b> Page 9 of 11	
	<b>Propulsion, Performance Podded Propulsor Tests and Extrapolation</b>	Effective Date 2002	Revision 00

ded drive unit (found from a drag test on the strut unit with a dummy hub and extrapolated to full scale using higher Reynolds number tests and/or CFD calculations or correlation procedures).

11. **And/or:** Correct the open water thrust ( $T_{unit}$ ) and torque coefficients of the podded propulsor unit i.) for Reynolds number scale effects of the drag over the propeller blades, ii.) for the resistance of the podded drive unit (found from a drag test on the strut unit with a dummy hub and extrapolated to full scale using higher Reynolds number tests and/or CFD calculations or correlation procedures) and iii.) for the difference in Reynolds number between the open water unit tests and the self propulsion tests.
12. By consideration of the required thrust relation  $K_T/J^2$  and its intersection with the estimated full scale thrust coefficient curve for the podded unit, obtain the advance ratio of the full scale propeller operating point and the thrust ( $T_{unit}$ ) and torque coefficients.
13. Hence obtain the revolutions, delivered power, thrust, torque, etc. of the full scale ship.

### 3 PARAMETERS

#### 3.1 Parameters to be Taken into Account

- $F$  - Longitudinal towing force of the ship model
- $F_D$  - Towing force applied on the model at the self propulsion point of the ship
- $F_{T=0}$  - Longitudinal towing force at zero propeller thrust
- $n$  - Rotation rate of the propeller
- $Q$  - Propeller torque
- $R$  - Resistance of the ship model

- $t^*$  - Thrust deduction factor
- $T$  - Propeller thrust (subscript  $m$  and  $s$  for model and ship respectively)
- $T_{unit}$  - Total thrust of the podded propulsor as a unit.
- $V$  - Velocity of the ship model
- $\lambda$  - Scale ratio of model
- $\rho$  - Water density (subscript  $M$  and  $S$  for model and ship respectively)

#### 3.2 Recommendations of ITTC for Parameters

##### 22<sup>nd</sup> ITTC Proceedings 1999

p. 59-61

Performance prediction methods for azimuthing thrusters as main propulsors are not well established. Turbulence simulators on the housings of model podded propulsors with pushing propellers are necessary.

In the area of powering performance extrapolation the situation has developed that the diversity of the procedures has widened instead of converging to one or two standard methods.

Evaluate performance prediction procedures for ships with azimuthing thrusters as the main propulsor.

p. 343-4

For powering prediction it is recommended that ship models fitted with unconventional propulsors, such as propellers with ducts, partial ducts, pre- and post- swirl devices, **z-drives**, etc., should be tested as a unit and not broken down into component tests of the hull, propulsor and rotor and stator components.

Extrapolation of full scale powering for unconventional propulsors should be done using self-propulsion load varying tests of the geo-

	<b>ITTC – Recommended Procedures</b>	<b>7.5 - 02</b> <b>03-01.3</b> Page 10 of 11	
	<b>Propulsion, Performance Podded Propulsor Tests and Extrapolation</b>	Effective Date 2002	Revision 00

metrically similar ship model and geometrically similar propulsor.

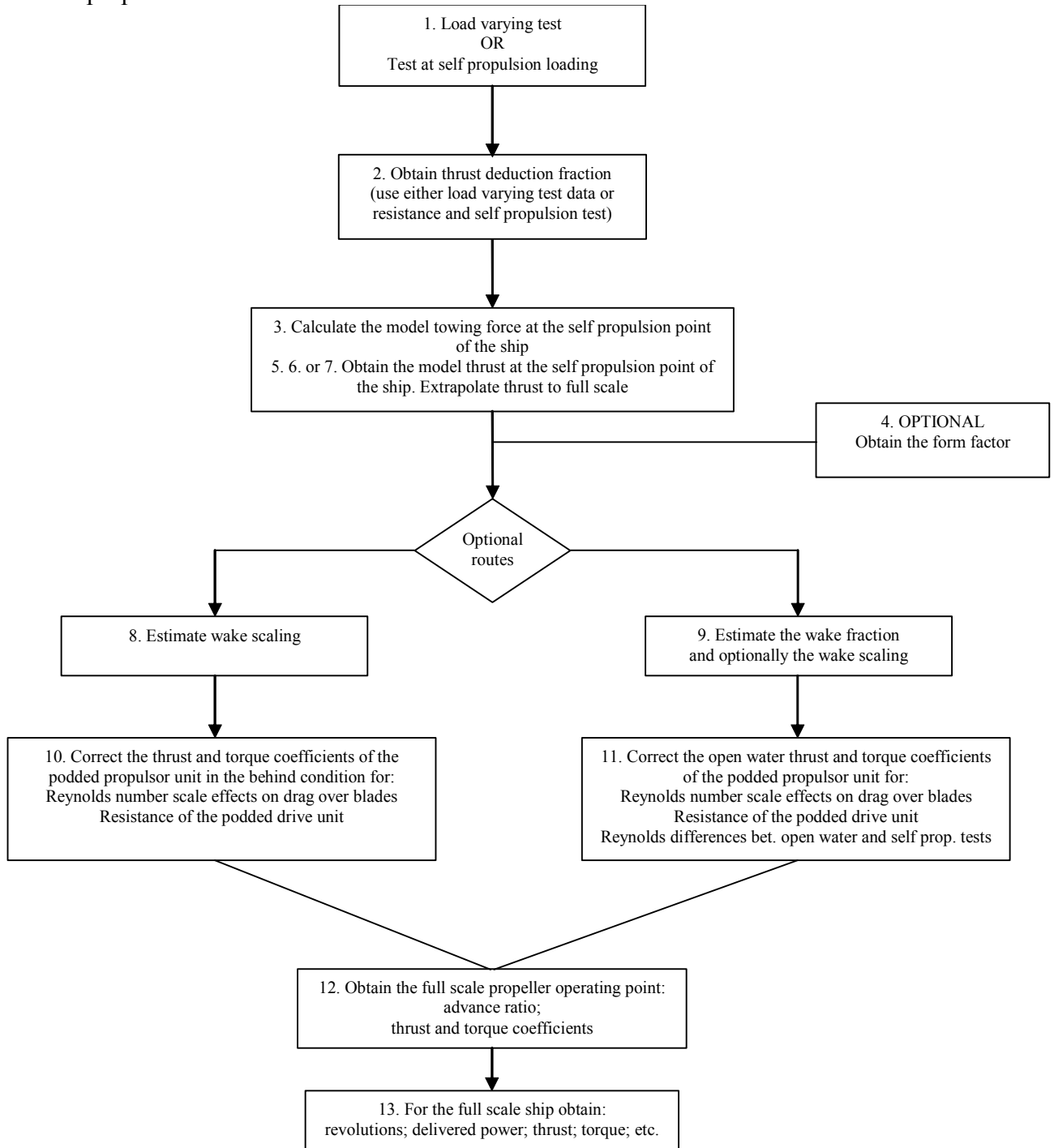



Figure 2.4.2 Extrapolation procedure

	<b>ITTC – Recommended Procedures</b>		<b>7.5 - 02</b> <b>03-01.3</b> Page 11 of 11	
	<b>Propulsion, Performance  Podded Propulsor Tests  and Extrapolation</b>		Effective Date 2002	Revision 00

To reduce/eliminate the scaling of flow separation effects during self-propulsion tests, these tests should be done at higher levels of Reynolds number than can be achieved by rigid adherence to Froude number scaling.

#### 4 VALIDATION

##### 4.1 Benchmark Tests

None

#### 5 REFERENCES

- (1) Holtrop, J., 2001, Extrapolation of propulsion tests for ships with appendages and complex propulsors, *Marine Technology*, **38** (3), 145-157.
- (2) Mewis, F., 2001, "Efficiency of Pod Propulsion", Proc. 22<sup>nd</sup> HADMAR Conference, Varna, Bulgaria.